

Product Specification

Product Name: Dreamcolor COB LED STRIP

Product Model: LC-COBX1008XM25W-5V

Version No.: V1.1

Page: Page 6 of 6



Note: If the product specifications are changed or the products are discontinued without notice, please consult our sales representatives or product engineers before ordering.

1. Product description

Dream color COB LED Strip is an LED electronic light-emitting product that uses FPCB (Flexible Printed Circuit Board) as the main carrier, uses SMD LED lights and electronic components as the load. The light-emitting surface of the product is uniform and has no dark areas. The COB LED Strip has strong deformability, and can be cut and rolled at will, which makes it highly flexible and strong variable in engineering applications. Various complex pattern changes can be made, it can also be used to hook the outline of the main body, and can also be used in irregular places and places with narrow space.

The product adopts DC5V direct current low-voltage power supply mode, with high safety factor and simple project acceptance procedure. The light source adopts the brand chip with excellent reputation in the industry, with high brightness, low light decay, energy saving and environmental protection, and long service life. Based on the above advantages, the product can be applied to indication and advertising signs, indoor/outdoor decoration of household, decoration of hotels and shopping malls, museums, exhibition halls and so on.

2. LED Strip Picture

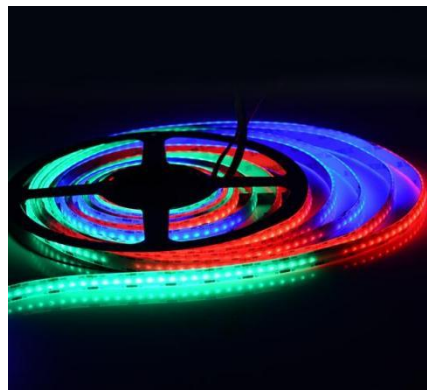

3. Features

- ★ It adopts chips from international brand manufacturers, with high brightness, large angle, good color consistency and stable performance.
- ★ Flexible tailoring, with arbitrary length, can be tailored on the complete circuit according to requirements, without destroying the principle performance.
- ★ Beautiful, energy-saving, high brightness and low heat generation, it is a pollution-free product that meets the ROHS standard.
- ★ IP Rating: IP20, IP65, IP67, IP68, the LED Strip is used in a wider range of site environments.
- ★ No radiation, safer to use.
- ★ The beam angle can reach 180°
- ★ Antistatic grade (MIL-STD-883E): HBM 2 grade (2000-4000V)

4. Product Warranty

- ★ Product warranty: two years, three years, five years, please note the warranty period for orders.

Add: 4-5/F Dadong Ming Technology Park, Yuequn Road, Changzhen, Guangming District, Shenzhen, China

Tel: 0755-27350605

Fax: 0755-23245913

HTTP: www.color-led.com

5.LED Strip Dimension

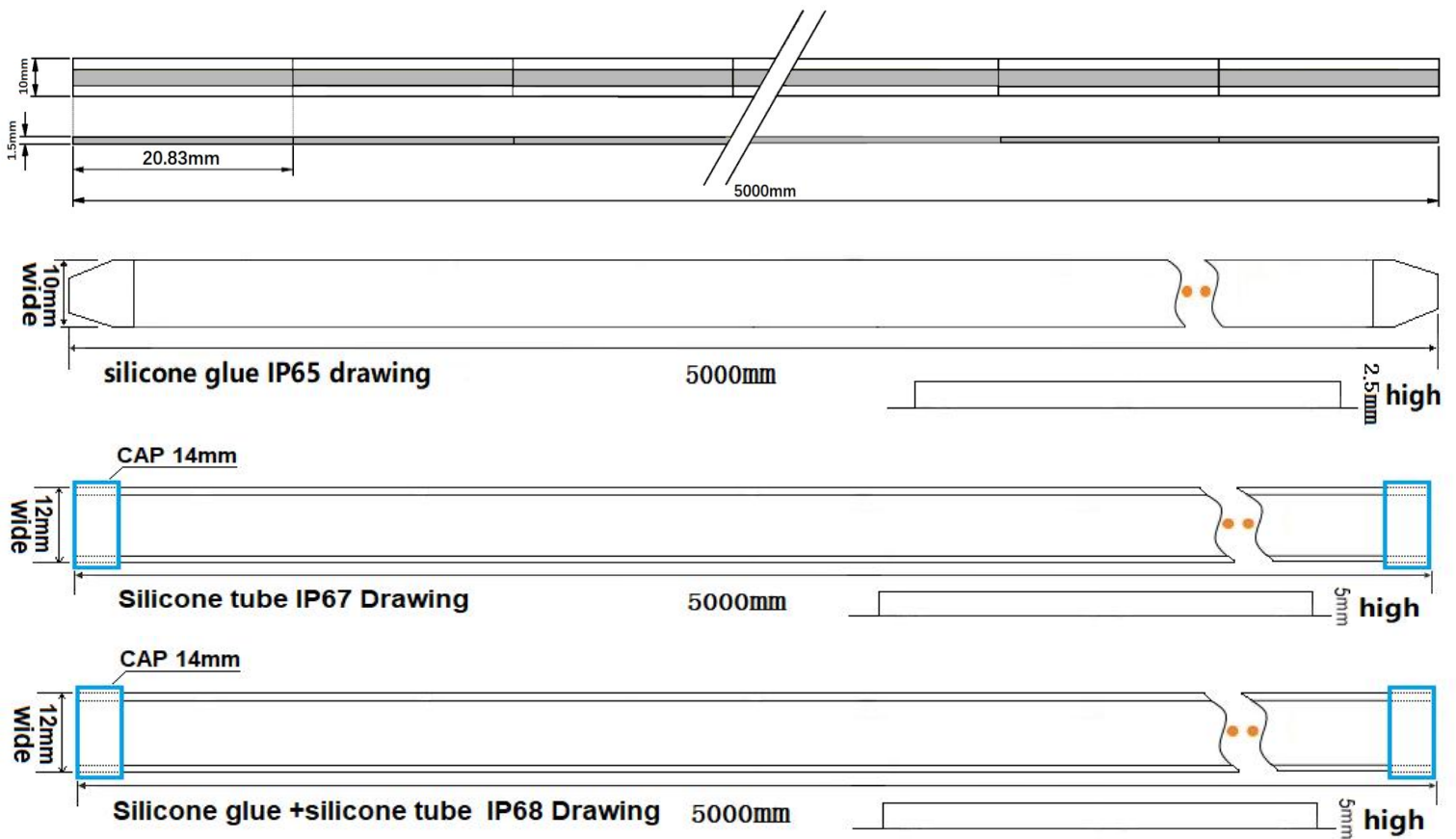

6.Electrical parameters

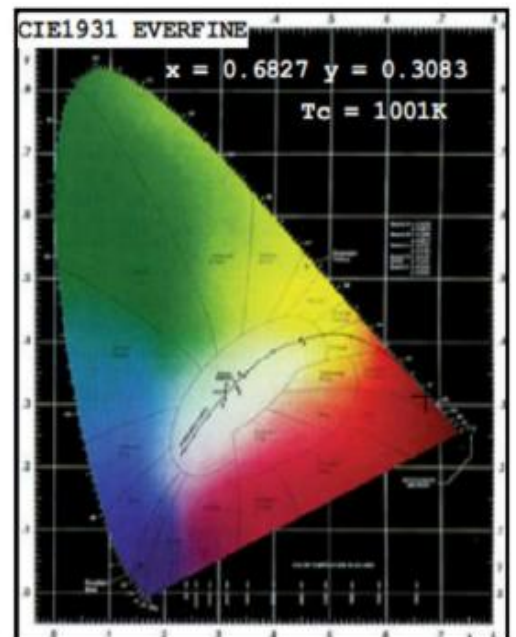
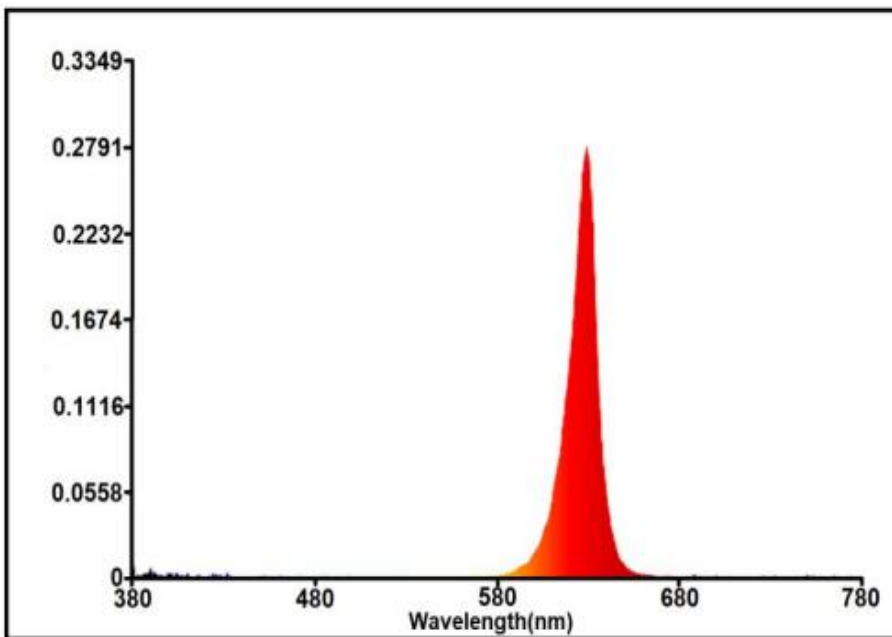

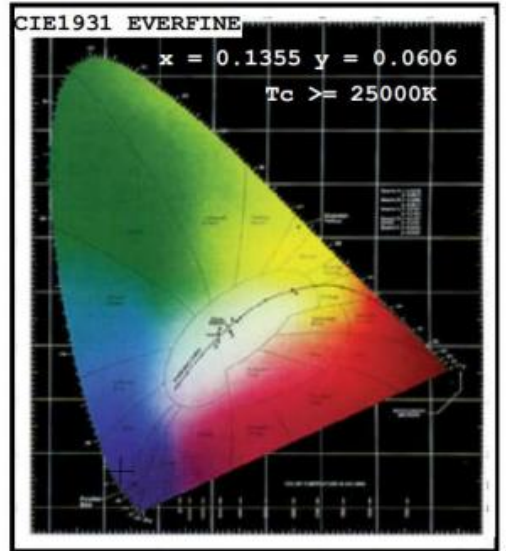
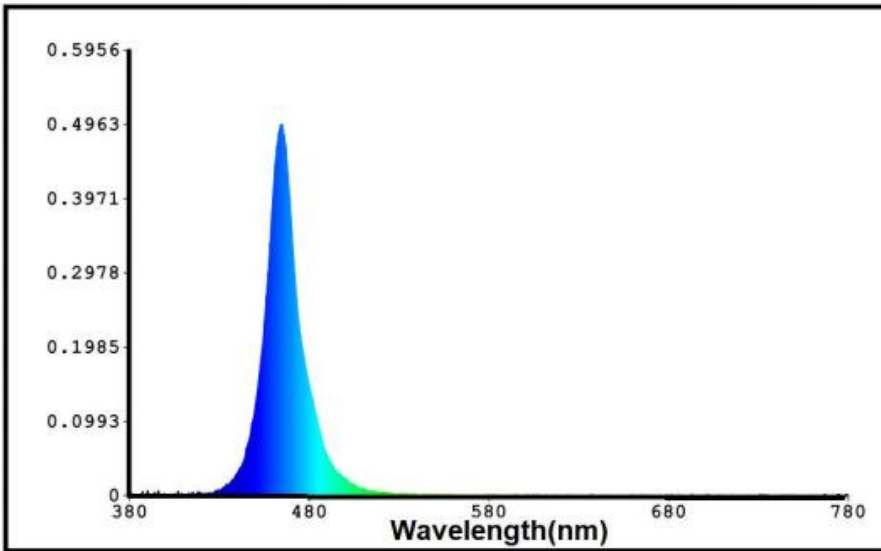
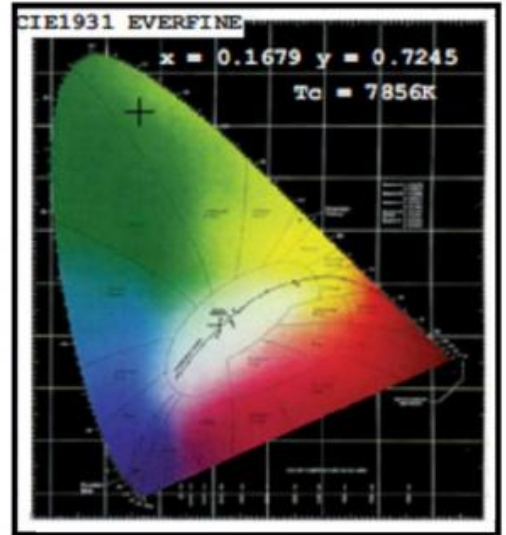
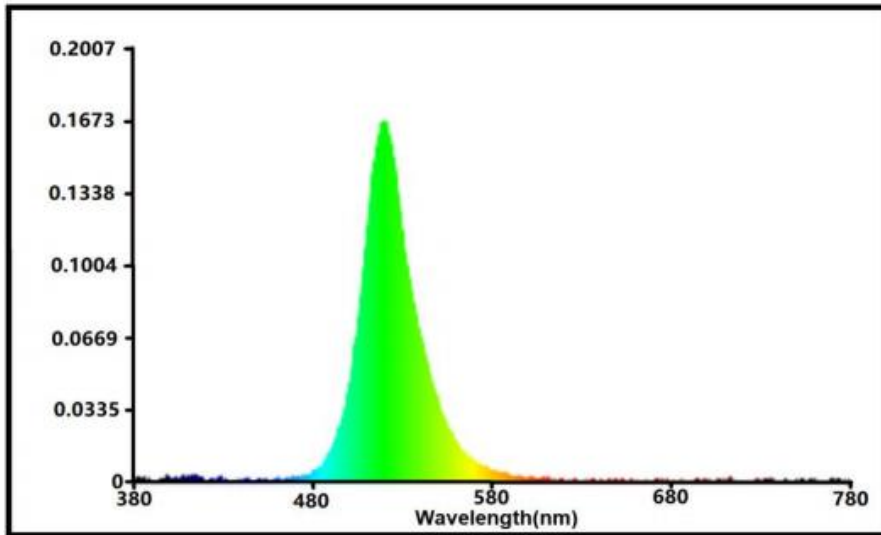

LED Strip parameters:

Product No.	LED Qty	Power	Voltage	Width	Color	Wavelength	Luminance
LC-COBX1008XM 25W-5V	1008LED	25W	DC5V	10mm	RGB	R:620-635nm	250LM-500LM
						G:510-525nm	300LM-600LM
						Blue:450-465nm	150LM-400LM

7.Packing

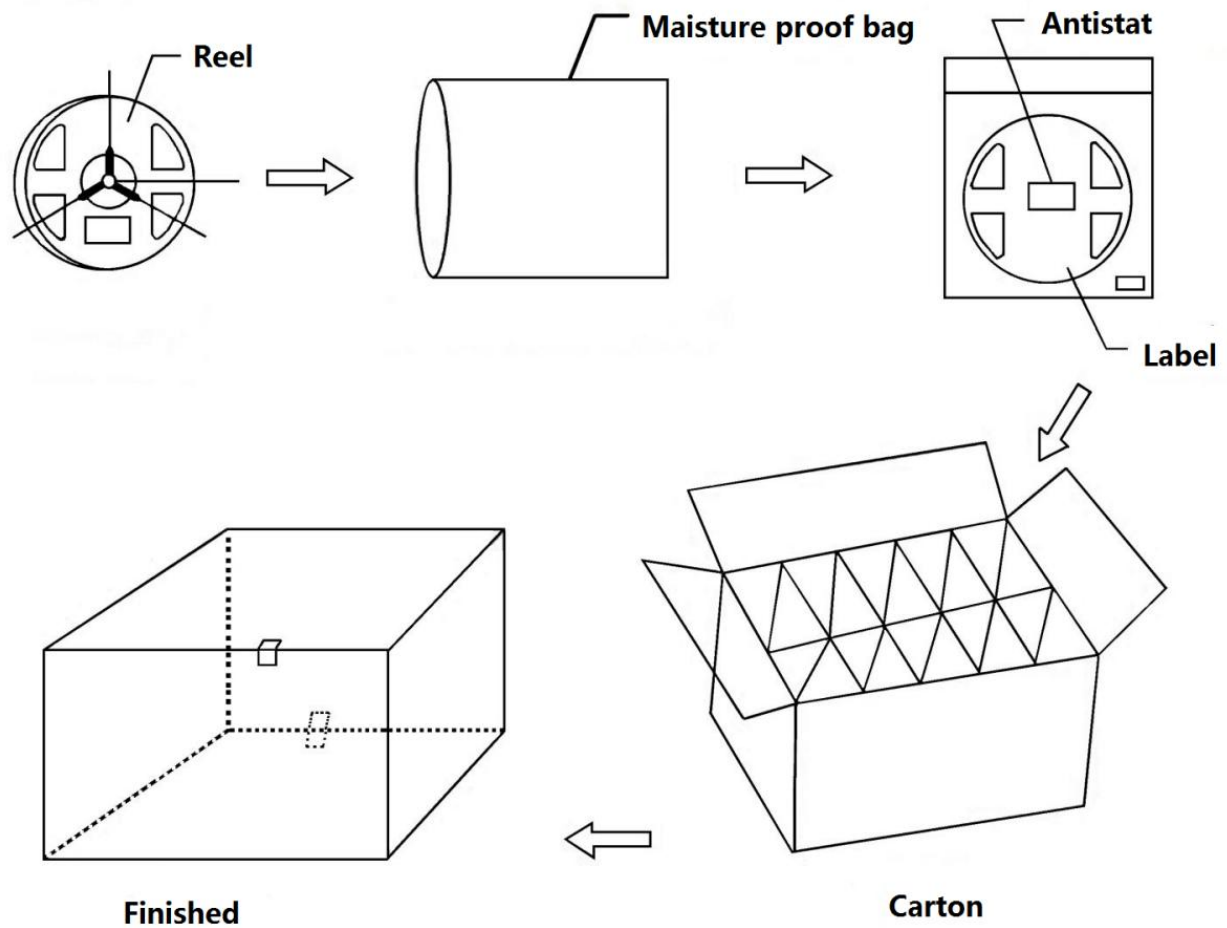

Note: This picture is only used for regular product packaging. For customized products, the packaging method will be different depending on the actual size, and the packaging method will be individually customized.

8.Connection Diagram

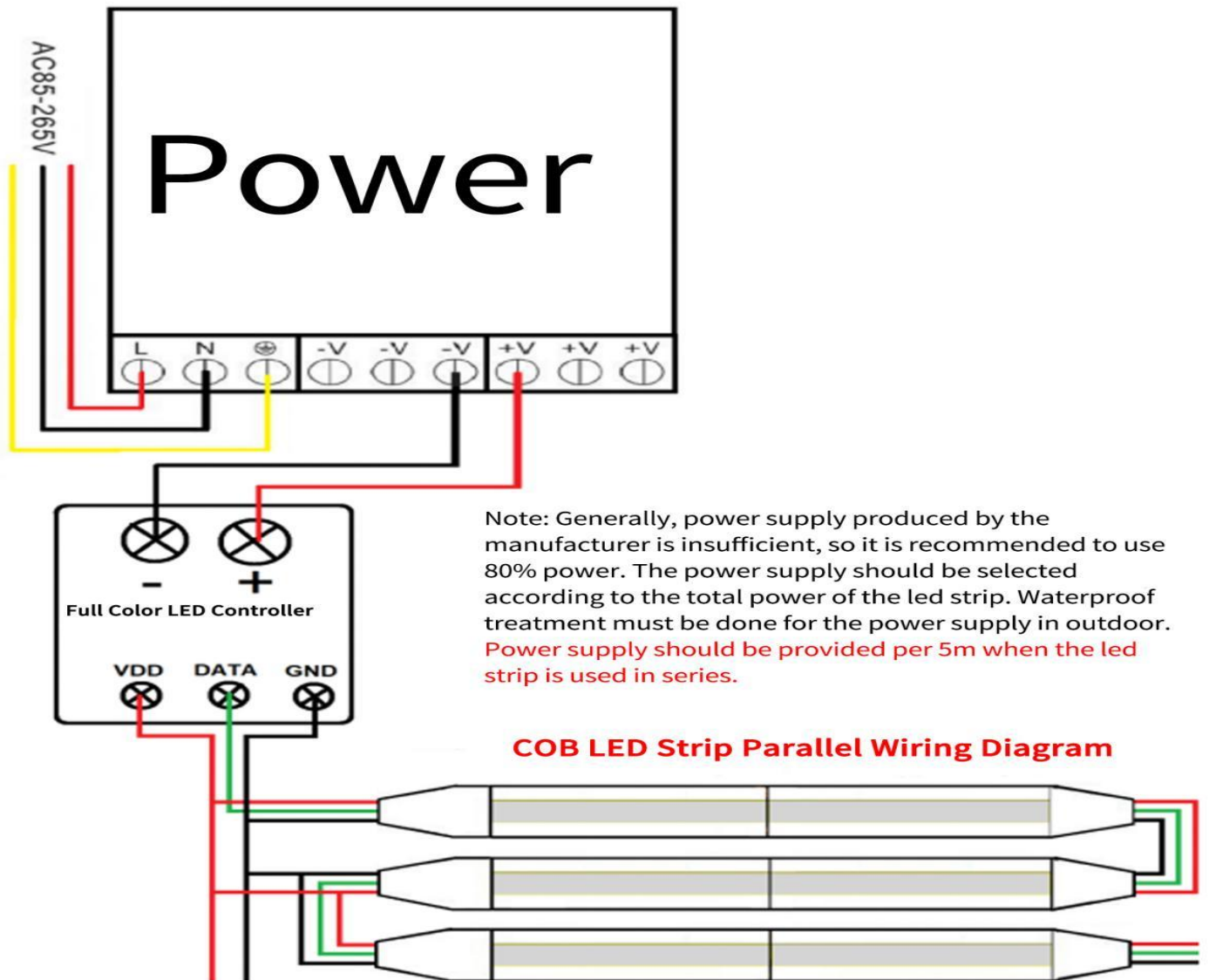

NOTE :

1. The AC wiring must be connected to the ground wire to prevent electric shock.
2. The overload current of the main wire of the LED Strip is the sum of the current of each sub-wire, so in the actual engineering application, the type of the main wire should be appropriately increased to prevent the wire from overheating and causing an accident.
3. This specification is only for the company's conventional products, special customized products have specified parameters, which are not within the scope of this specification
4. The product shall not be bent or twisted in use, and the diameter shall be less than 5mm.